

High Power

SEN CC 033 Fixture Guide

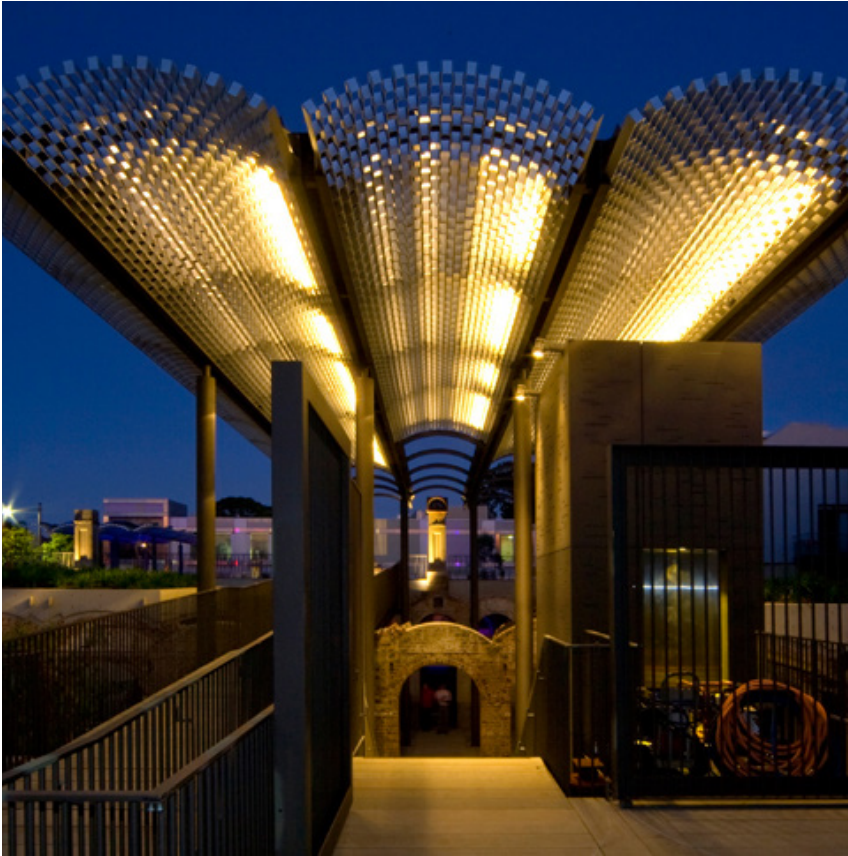

Indoor/Outdoor | Surface | Output up to 5673lm/m (1729lm/ft)



Key applications

- ✓ Backlighting/Signage
- ✓ Building façades
- ✓ Ceiling
- ✓ Cove lighting
- ✓ Downlighting
- ✓ Flood lighting
- ✓ Interior/Exterior
- ✓ Public spaces
- ✓ Wall grazing
- ✓ Window Reveal

Key features

- ✓ Custom lengths
- ✓ Diffusion: Spotting
- ✓ Direct view
- ✓ High lumen efficacy
- ✓ IP44
- ✓ IP67
- ✓ Lensed

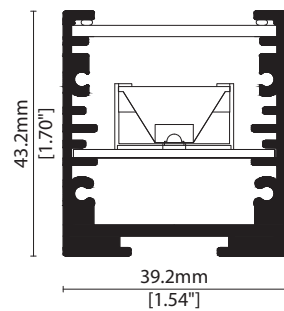

MOUNTING METHODS



KKCP-12 Lock clip



KKBK-02 Fixed bracket



KKBK-09 Mounting plate



KKBK-16 Small adjustable bracket



KKBK-17 Large adjustable bracket



KKBK-23 Low adjustable bracket



SEN CC 033

Specification sheet



Dimensions	H43.2/W39.2/L210-1210mm (H1.70/W1.54/L8.27-47.64in) 610mm (24.02in) max for UL
PCB Cut-point	100mm (3.94in)
LED Pitch	33mm - 30LED/m (1.30in - 9.1LED/ft)
Chip	hcc-line: CREE/Lumileds
Cover/Optics	Clear + 10°/20°/30°/60°/Spread lens (10°x45°)/No lens/Micro louvre
CCT	hcc-line White: 2700K/3000K/3500K/4000K/5000K hcc-line Single colours: Red/Green/Blue
LED binning	hcc-line: 3-step MacAdam Ellipse
CRI	80 (2700K-4000K)/75 (5000K)
Lifetime	50,000 hours @ 25°C (50,000 hours @ 77°F)
Operating temp	350mA: T _a = -25 to 70°C (T _c max = 85°C) T _a = -13 to 158°F (T _c max = 185°F) 700mA: T _a = -25 to 30°C (T _c max = 47°C) T _a = -13 to 86°F (T _c max = 116.6°F)
IP Rating	IP44/67
Finish	Silver anodised
Mounting	Surface mounting via brackets
Power feed	Sheathed hardwire tail
Control	0-10V/1-10V/DMX/DALI via. External power supply options



LED Grading Key

Exclusive Grade		
h- hcc-line*	Constant Current Lensed	*KKDC tuned CCT range
	High Power LED	
	3-step CCT range	

Power consumption	Supply voltage	Supply current
TYP. 30W/m (9.14W/ft) @ 350mA	TYP. 86V/m (26.21V/ft) @ 350mA	0.35/0.7A/m (0.11/0.21A/ft)
TYP. 61W/m (18.59W/ft) @ 700mA	TYP. 87V/m (26.51V/ft) @ 700mA	

	Clear Cover 10°	Clear Cover 20°	Clear Cover 30°	Clear Cover 60°	Clear Cover Spread lens	Clear Cover No Lens	Clear Cover + Micro Louvre	CRI	R9	Rf	Rg
hcc-line	2973lm/m (906lm/ft)	2973lm/m (906lm/ft)	2730lm/m (832lm/ft)	3180lm/m (969lm/ft)	2880lm/m (878lm/ft)	2370lm/m (722lm/ft)	-60% Output when combined with Cover and Lens options	-	-	-	-
	99lm/W @ 3000K, 350mA	99lm/W @ 3000K, 350mA	91lm/W @ 3000K, 350mA	106lm/W @ 3000K, 350mA	96lm/W @ 3000K, 350mA	79lm/W @ 3000K, 350mA					
	5325lm/m (1623lm/ft)	5307lm/m (1618lm/ft)	4941lm/m (1506lm/ft)	5673lm/m (1729lm/ft)	5185lm/m (1580lm/ft)	4270lm/m (1301lm/ft)	-60% Output when combined with Cover and Lens options	-	-	-	-
	87lm/W @ 3000K, 700mA	87lm/W @ 3000K, 700mA	81lm/W @ 3000K, 700mA	93lm/W @ 3000K, 700mA	85lm/W @ 3000K, 700mA	70lm/W @ 3000K, 700mA					

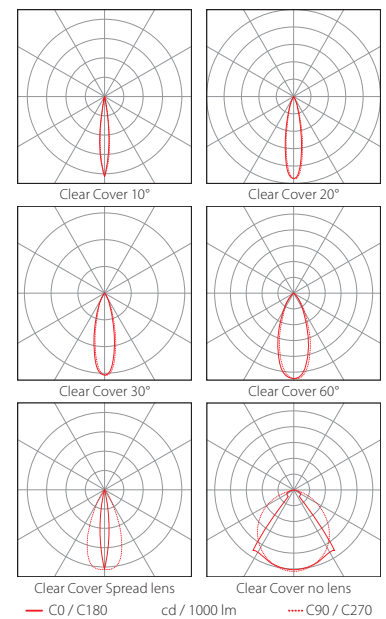
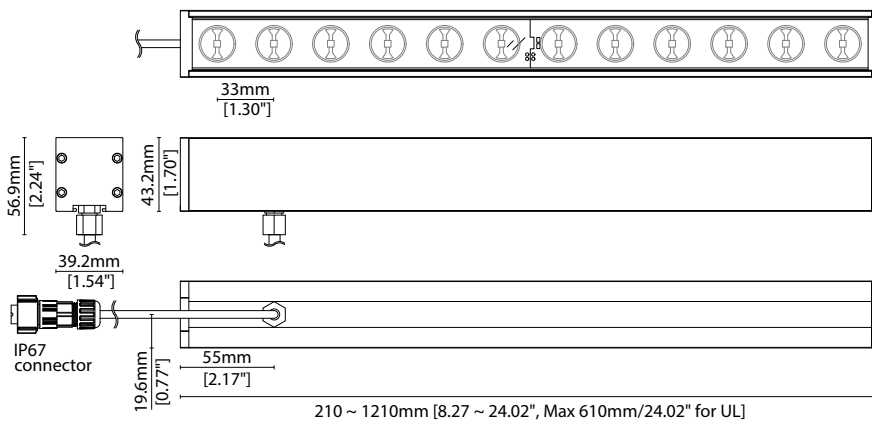

Data derived from independent UKAS/IESNA LM-79-08 accredited testing of production samples.



SEN CC 033

Code Table



FIXTURE

Model	Finish	Cover/Lens ¹	Grade ²	LED	Colour	Length Availability ³	IP	Cable Length	Power Feed ⁴	Cable Exit ⁵	Lens	Input			
SEN	SN Silver Anodised	Clear Clear+ Micro Louvre	B h h	033	2700K	27	m 210-1210mm 100mm increments	IP44 44 IP67 ⁶ 67	1000mm 1000 /39.37"	Single ø6.3mm sheath tail	S00B	Rear Cable Exit RC	No lens XX 10° 10 20° 20 30° 30 60° 60 Spread Lens SL	Constant current (DC) a	
					3000K	30									
					3500K	35									i 8.27-47.64in 3.94in increments
					4000K	40									
					5000K	50									(Specify length code OR total run length)
					RED	RED									
					GREEN	GRN									
BLUE	BLU														

¹ Refer to **Cover Options** on **Options** pages

² Refer to **LED Grading Key** on **Specification sheet** page

³ Refer to **Length Availability List** or enter total run length instead of length code

⁴ Refer to **Power Feed Options** on **Options** pages

⁵ Refer to **Cable Exit Options** on **Options** pages

⁶ Due to the clear, flush potted polyurethane top layer on IP67 SEN a colour shift of +/-20K should be expected

⁷ Low adjustable bracket needs side cable exit option

Code Example:

SN	-	SA	-	B	-	h	-	033	-	35	-	m	1210	-	67	-	1000	-	S67B	-	RC	-	30	-	a
SEN		Silver anodised		Clear		h		033		3500K		m	1210mm		IP67		1000mm/39.37"		Single ø6.3mm sheath IP67 connector		Rear Cable Exit		30°		Constant current (DC)

ACCESSORIES

Mounting Accessories

KKCP-12	Lock Clip
KKBK-02	Fixed bracket
KKBK-09	Mounting plate
KKBK-16	Small adjustable bracket
KKBK-17	Large adjustable bracket
KKBK-23	Low adjustable bracket

* Refer to **Mounting accessories** on **Accessories** pages

Exterior Junction Boxes

KKJB-07	IP67 Slim J-Box
KKJB-07R	Potting Resin for IP67 Slim J-Box

* Refer to **Exterior Junction Boxes** on **Accessories** pages

PSU/Driver

0-10V/1-10V/DALI/DMX via External power supply options

* Refer to **Driver/PSU Options** page for details or provide requirement and KKDC to offer the suitable option

LED ENGINE VARIANTS (LED STRIP TYPE)

Colour	LED	Lumen/m	Lumen/ft	W/m	W/ft	Spec Doc	Length	Increment
Single CCT	033	3791	1155	69.3	21.12	SEN CC 033	210-1210mm (8.27-47.64in)	100mm (3.94in)
	050	2297	700	46.2	14.08	SEN CC 050	210-1810mm (8.27-71.26in)	100mm (3.94in)
	100	1269	387	23.1	7.04	SEN CC 100	210-1810mm (8.27-71.26in)	100mm (3.94in)

* Performance data: hcc-line, clear cover 60° lens, 700mA, 3000K

High Power

SEN CC 033 (350mA) Length Availability List



Length Code		Fixture Length ¹		LED Strip ²		End Cap Dimension ³		Wattage (W)	Output (lm)
Metric	Imperial(US)	Metric	Imperial(US)	Metric	Imperial(US)	Metric	Imperial(US)		3000K (Test Data)
m0210	i0008	210mm	8.27in	200mm	7.87in	10mm	0.39in	5.92	626
m0310	i0012	310mm	12.20in	300mm	11.81in	10mm	0.39in	8.88	939
m0410	i0016	410mm	16.14in	400mm	15.75in	10mm	0.39in	11.84	1251
m0510	i0020	510mm	20.08in	500mm	19.69in	10mm	0.39in	14.80	1564
m0610	i0024	610mm	24.02in	600mm	23.62in	10mm	0.39in	17.76	1877
m0710	i0028	710mm	27.95in	700mm	27.56in	10mm	0.39in	20.72	2190
m0810	i0032	810mm	31.89in	800mm	31.50in	10mm	0.39in	23.68	2503
m0910	i0036	910mm	35.83in	900mm	35.43in	10mm	0.39in	26.64	2816
m1010	i0040	1010mm	39.76in	1000mm	39.37in	10mm	0.39in	29.60	3129
m1110	i0044	1110mm	43.70in	1100mm	43.31in	10mm	0.39in	32.56	3442
m1210	i0048	1210mm	47.64in	1200mm	47.24in	10mm	0.39in	35.52	3754

¹ Actual total overall length of light fixture (LED strip + end caps + void/wire hole)

² Actual length of PCB strip

³ Actual length of 2x end caps

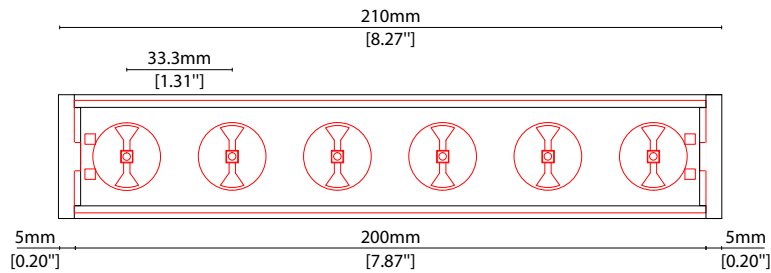

High Power

SEN CC 033 (700mA) Length Availability List



Length Code		Fixture Length ¹		LED Strip ²		End Cap Dimension ³		Wattage (W)	Output (lm)
Metric	Imperial(US)	Metric	Imperial(US)	Metric	Imperial(US)	Metric	Imperial(US)		3000K (Test Data)
m0210	i0008	210mm	8.27in	200mm	7.87in	10mm	0.39in	12.12	1128
m0310	i0012	310mm	12.20in	300mm	11.81in	10mm	0.39in	18.18	1693
m0410	i0016	410mm	16.14in	400mm	15.75in	10mm	0.39in	24.24	2257
m0510	i0020	510mm	20.08in	500mm	19.69in	10mm	0.39in	30.30	2821
m0610	i0024	610mm	24.02in	600mm	23.62in	10mm	0.39in	36.36	3385
m0710	i0028	710mm	27.95in	700mm	27.56in	10mm	0.39in	42.42	3949
m0810	i0032	810mm	31.89in	800mm	31.50in	10mm	0.39in	48.48	4513
m0910	i0036	910mm	35.83in	900mm	35.43in	10mm	0.39in	54.54	5078
m1010	i0040	1010mm	39.76in	1000mm	39.37in	10mm	0.39in	60.60	5642
m1110	i0044	1110mm	43.70in	1100mm	43.31in	10mm	0.39in	66.66	6206
m1210	i0048	1210mm	47.64in	1200mm	47.24in	10mm	0.39in	72.72	6770

¹ Actual total overall length of light fixture (LED strip + end caps + void/wire hole)

² Actual length of PCB strip

³ Actual length of 2x end caps

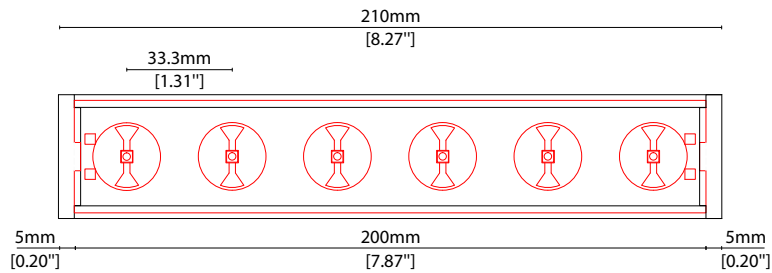

COVER LENS OPTIONS

* Options are an integral part of the fixture ordering codes. Please refer to **Code Table** pages.

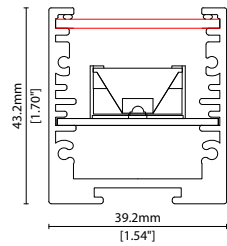

B 10 Clear cover 10° lens
W39.2/H43.2mm (W1.54/H1.70")

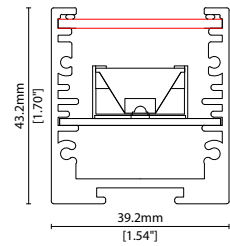

B 20 Clear cover 20° lens
W39.2/H43.2mm (W1.54/H1.70")

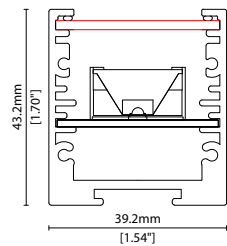

B 30 Clear cover 30° lens
W39.2/H43.2mm (W1.54/H1.70")

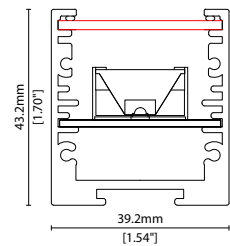

B 60 Clear cover 60° lens
W39.2/H43.2mm (W1.54/H1.70")

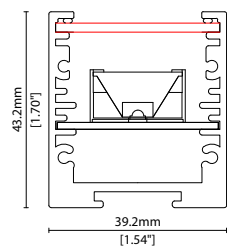

B SL Clear cover + Spread lens
W39.2/H43.2mm (W1.54/H1.70")

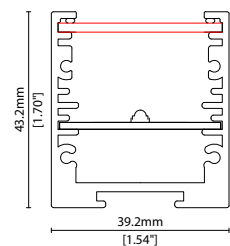

B XX Clear cover no lens
W39.2/H43.2mm (W1.54/H1.70")

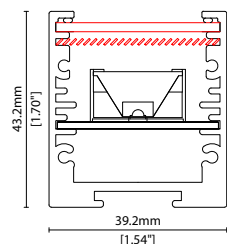

K Clear cover + Micro louvre
W39.2/H43.2mm (W1.54/H1.70")

CABLE EXIT OPTIONS

* Options are an integral part of the fixture ordering codes. Please refer to **Code Table** pages.

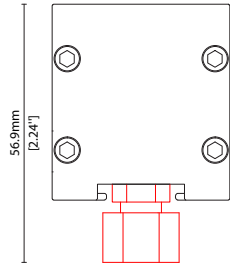

RC Rear cable exit

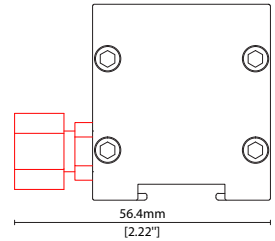

SC Side cable exit

POWER FEED OPTIONS

0300 S00B 300mm (11.81") Single Ø6.3mm sheath tail

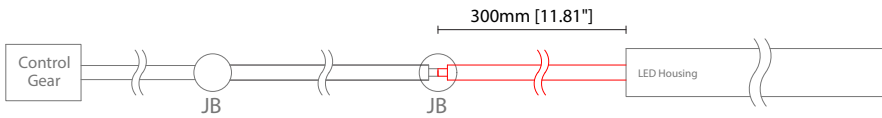

0300 D00B 300mm (11.81") Double Ø6.3mm sheath tail

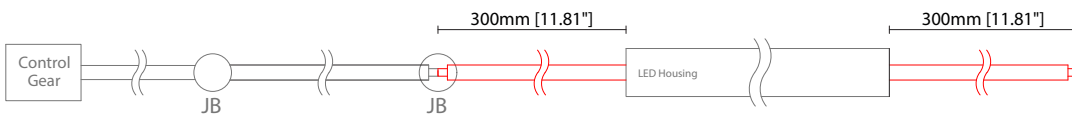

0300 S67B 300mm (11.81") Single Ø6.3mm sheath IP67 connector

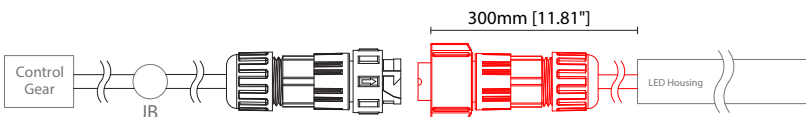

0300 D67B 300mm (11.81") Double Ø6.3mm sheath IP67 connector

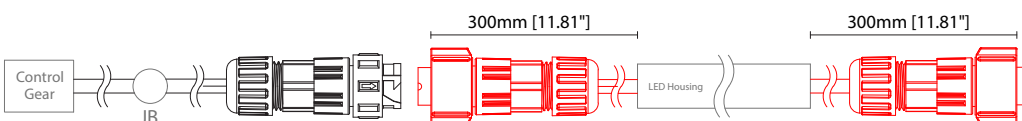

IP67 2 Pin Connector

Female connector
2 PIN (IP67)

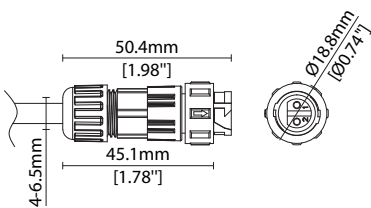

Male connector
2 PIN (IP67)

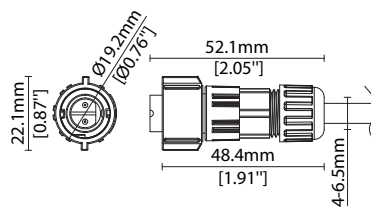

Key

Control Gear Power supply, sub-controllers & control systems

JB Junction box / cable connection

MOUNTING ACCESSORIES

Note: Accessories are to be ordered separately with corresponding code shown below.



KKCP-12
Lock clip (allow 2 per metre/40in)
S/Steel finish

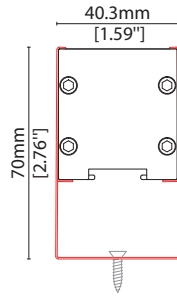

KKBK-02
Fixed bracket (allow 2 per metre/40in)
Steel finish
Pre-assembled for double tail

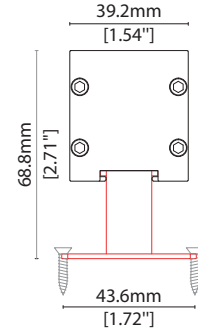

KKBK-09
Mounting plate
(allow 2 per metre/40in – factory fitted)
Silver anodised aluminium finish
Pre-assembled for double tail

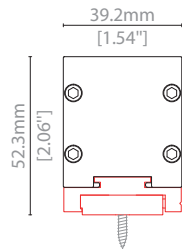

KKBK-23
Low adjustable bracket
(allow 2 per metre/40in)
Silver anodised aluminium finish
Pre-assembled for double tail

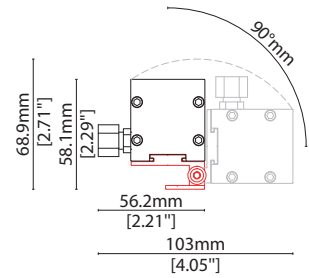

KKBK-16
Small adjustable bracket
(allow 2 per metre/40in)
Silver anodised aluminium finish
Pre-assembled for double tail

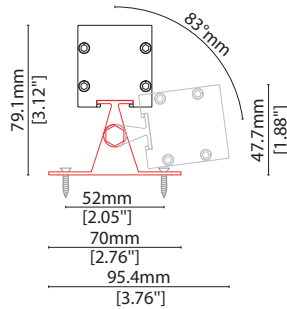

KKBK-17
Large adjustable bracket
(allow 2 per metre/40in)
Silver anodised aluminium finish
Pre-assembled for double tail

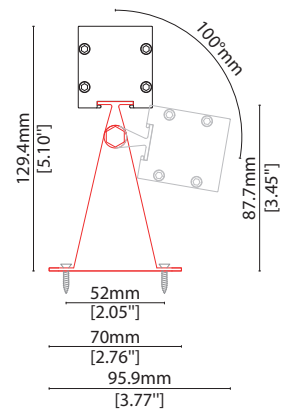



SEN CC 033 Accessories



EXTERIOR JUNCTION BOXES



KKJB-07

IP67 Slim J-Box
(including type A,B,C,D bushings)



KKJB-07R

Potting resin for IP67 Slim J-Box



SEN Driver/PSU Options



AVAILABLE PSU OPTIONS

Control Mode	PSU (Order Code)	Input Voltage AC	Output Voltage DC	Rated Output Current	Rated Power	Dim %	IP Rating
Switched	HLG-60H-C350A	90-305V	100V-200V	0.35A	70W	-	IP65
	HLG-60H-C700A	90-305V	50V-100V	0.7A	70W	-	IP65
	HLG-80H-C350A	90-305V	128V-257V	0.35A	90W	-	IP65
	HLG-80H-C700A	90-305V	64V-129V	0.7A	90W	-	IP65
	HLG-120H-C350A	90-305V	215-430V	0.35A	150W	-	IP65
	HLG-120H-C700A	90-305V	107V-215V	0.7A	150W	-	IP65
	HLG-185H-C700A	90-305V	143V-286V	0.7A	199W	-	IP65
0-10V (1-10V)	HLG-60H-C350B	90-305V	100V-200V	0.35A	70W	-	IP67
	HLG-60H-C700B	90-305V	50V-100V	0.7A	70W	-	IP67
	HLG-80H-C350B	90-305V	128V-257V	0.35A	90W	-	IP67
	HLG-80H-C700B	90-305V	64V-129V	0.7A	90W	-	IP67
	HLG-120H-C350B	90-305V	215-430V	0.35A	150W	-	IP67
	HLG-120H-C700B	90-305V	107V-215V	0.7A	150W	-	IP67
	HLG-185H-C700B	90-305V	143V-286V	0.7A	199W	-	IP67
DMX	POWERdrive 1060/A	120 - 277V	2V-57V	0.35A, 0.7A	100W	-	-
	POWERdrive 106/M	120 - 277V	2V-57V	0.35A, 0.7A	100W	-	-
	POWERdrive 106/S	120 - 277V	2V-57V	0.35A, 0.7A	100W	-	-
	POWERdrive 1061/M	120 - 277V	2V-57V	0.35A, 0.7A	100W	-	-
	POWERdrive 1061/S	120 - 277V	2V-57V	0.35A, 0.7A	100W	-	-
DALI	ELG-100-C350DA	180-295V	143-286V	0.35A	100W	-	IP67
	ELG-100-C700DA	180-295V	71-143V	0.7A	100W	-	IP67
	ELG-150-C700DA	180-295V	150-300V	0.7A	150W	-	IP67